

Details of Finial  
S=1/10

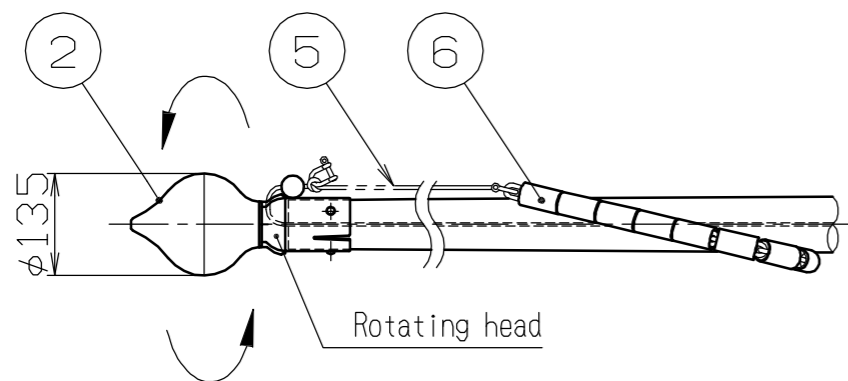

Details of cleat  
S=1/10

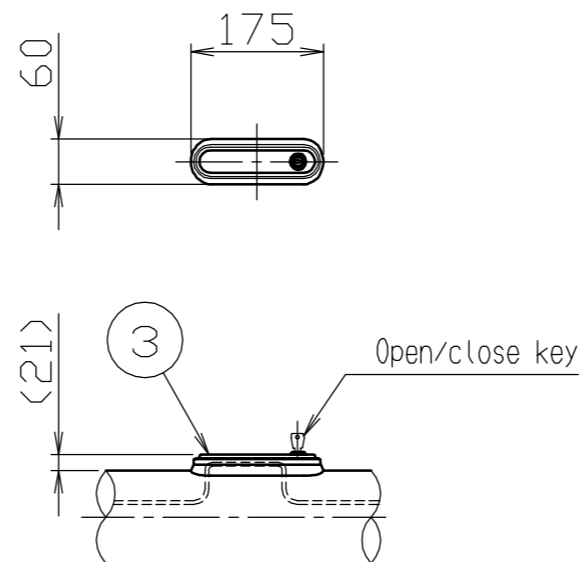

Details of Hing Base  
S=1/10

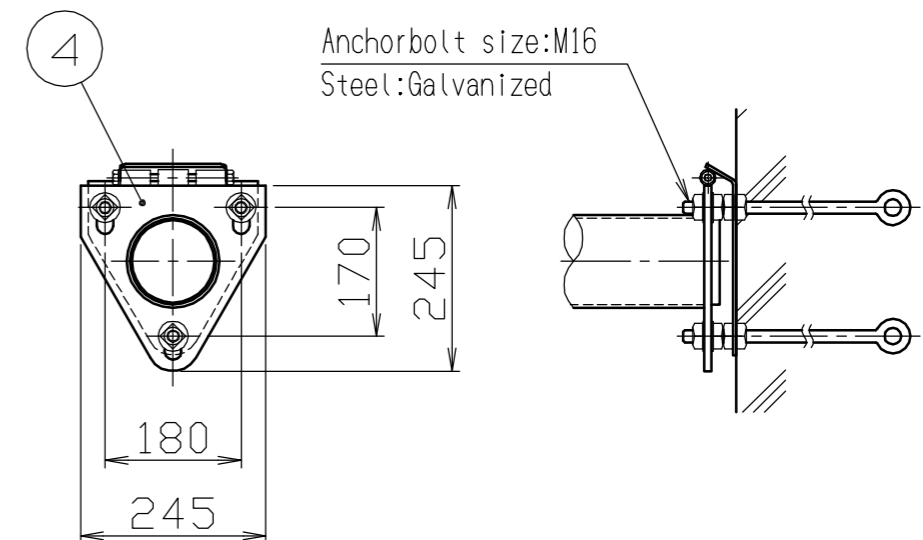

※ For safety, please refrain from using the flag when the wind speed is more than 15 meters/second.

6	Weight Ring	1	Iron chain/PVC pipe	galvanized
5	Rope	1	Polyester	5mm
4	Hinge Base	1	Steel plate/Steel pipe	φ114.3 galvanized
3	Locking Cleat	1	Abs resin	
2	Finial	1	Acrylic resin	φ135
1	Pole	1	Glass fiber reinforced resin	φ65-φ123 Gelcoating (Uv stabilizer)
No	Product Name	Q'ty	Material	Remarks

European Flagpole Co., Ltd. Sunpole Japan group			年月日 DATE	品名 SUBJ. MFP-8BS
承認 APPR.	検図 C. BY	製図 D. BY	尺度 SCALE 1 / 30	図番 DRAWING No.
				DWG A3 SIZE