

Details of Finial

S=1/10

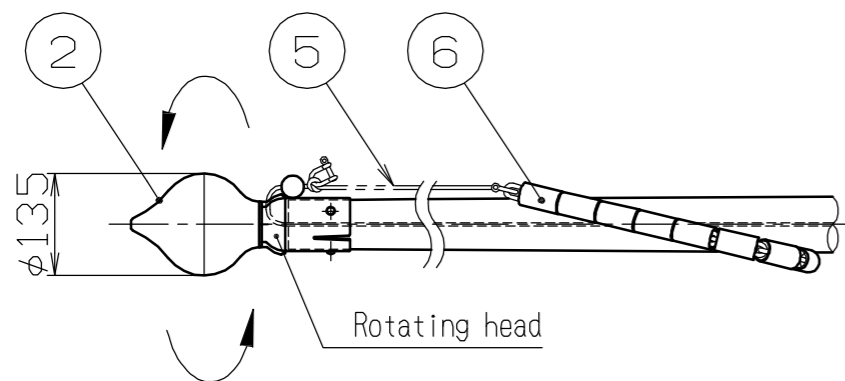

Details of cleat

S=1/10

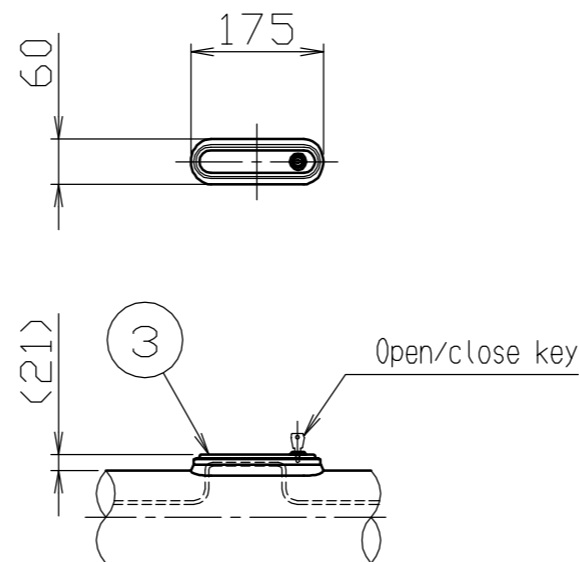

Details of Hingzi Base

S=1/10

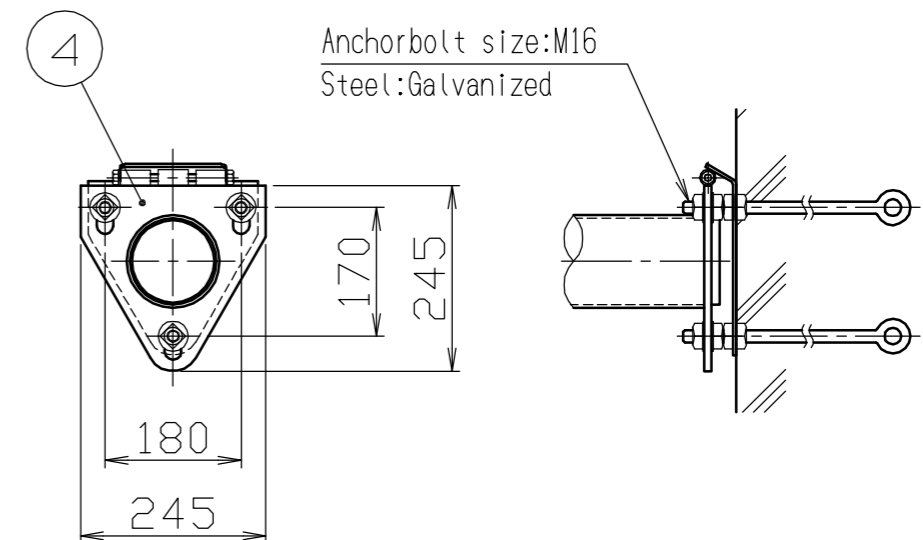

※ For safety, please refrain from using the flag when the wind speed is more than 15 meters/second.

6	Weight Ring	1	Iron chain/PVC pipe	galvanized
5	Rope	1	Polyester	5mm
4	Hinge Base	1	Steel plate/Steel pipe	φ114.3 galvanized
3	Locking Cleat	1	Abs resin	
2	Finial	1	Acrylic resin	φ135
1	Pole	1	Glass fiber reinforced resin	φ65-φ123 Gelcoating (Uv stabilizer)
No	Product Name	Q'ty	Material	Remarks

European Flagpole Co., Ltd.		年月日 DATE	品名	MFP-6BS
Sunpole Japan group			SUBJ.	
承認 APPR.	検図 C. BY	製図 D. BY	尺度 SCALE	図番 DRAWING No.
			1 / 30	

DWG
A3
SIZE
1908