

Details of Finial

S=1/10

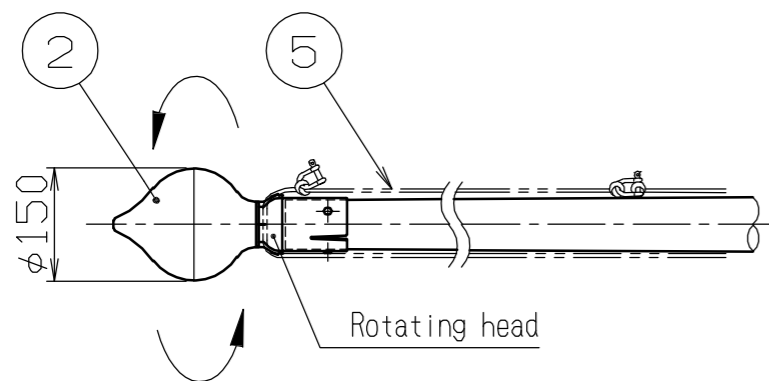

Details of cleat

S=1/10

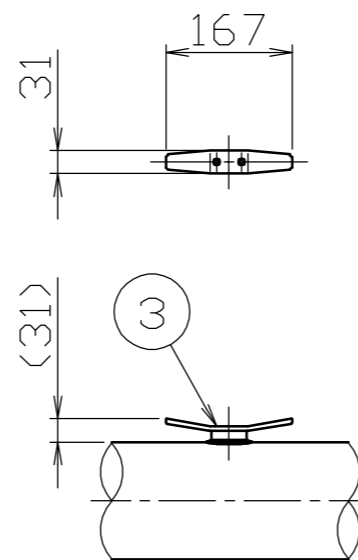

Details of Hing Base

S=1/10

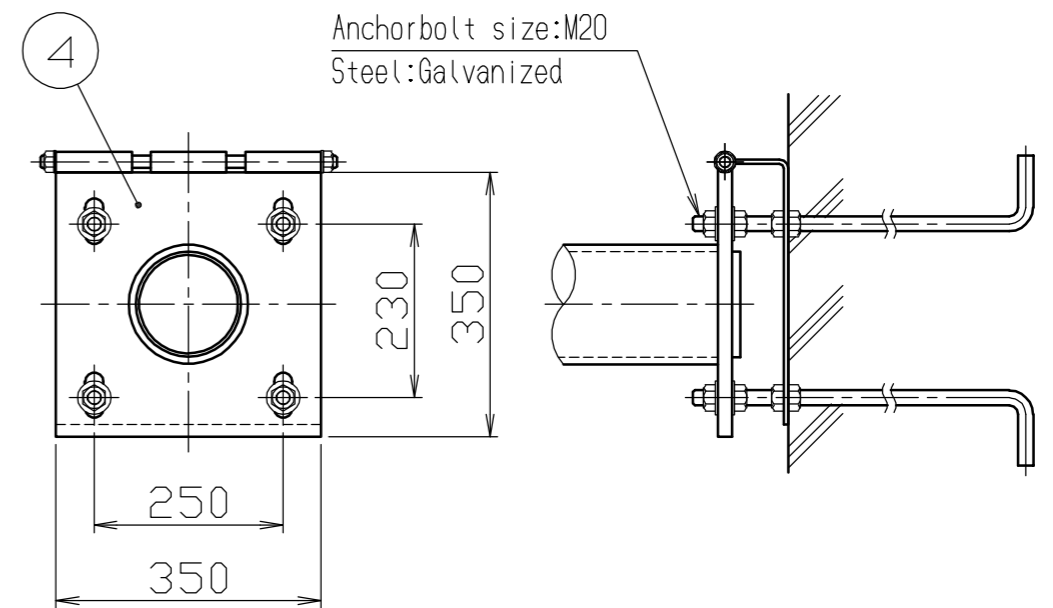

※ For safety, please refrain from using the flag when the wind speed is more than 15 meters/second.

No	Product Name	Q'ty	Material	Remarks
5	Rope	1	Polyester	6mm
4	Hinge Base	1	Steel plate/Steel pipe	φ 139.8 galvanized
3	Cleat	1	Abs resin	
2	Finial	1	Acrylic resin	φ 150
1	Pole	1	Glass fiber reinforced resin	φ 65-φ 159 Gelcoating (Uv stabilizer)

European Flagpole Co., Ltd.			年月日 DATE	品名 SUBJ.	CFP-16BS
Sunpole Japan group					
承認 APPR.	検図 C. BY	製図 D. BY	尺度 SCALE	図番 DRAWING No.	DWG A2 SIZE
			1 / 50		